

INSTRUCTION



10X10FT-BOOTH-L

STEPS

(1) Hardware

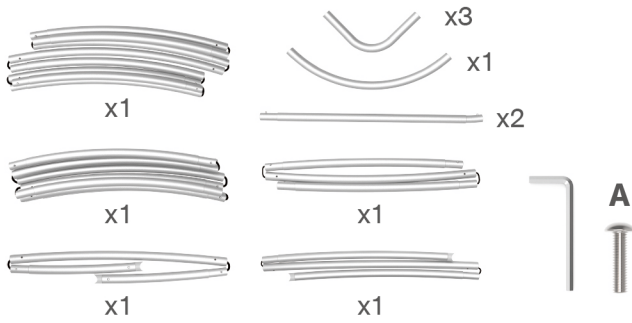

(2) Printed Graphic Fabric Banner (Optional)

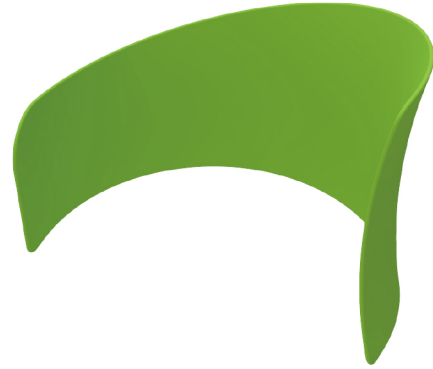

STEP 01

Connect to make long poles according to labelings.

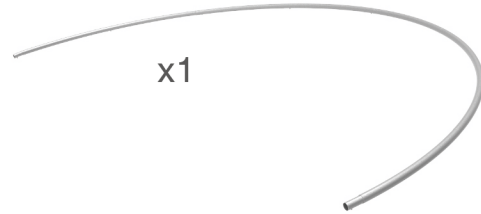
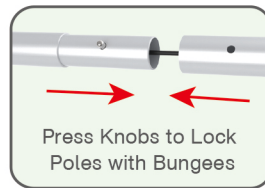

x1

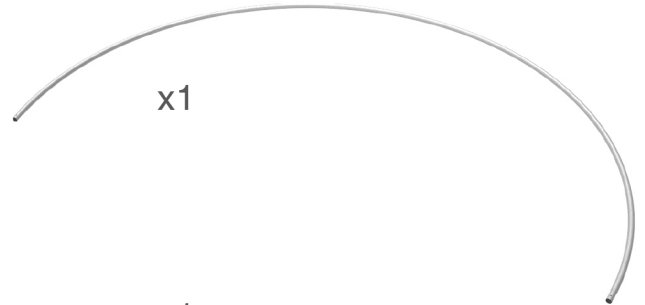

x1



x1



x1

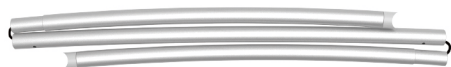

x1

STEPS

STEP 02

Connect long poles with corner poles according to labelings.

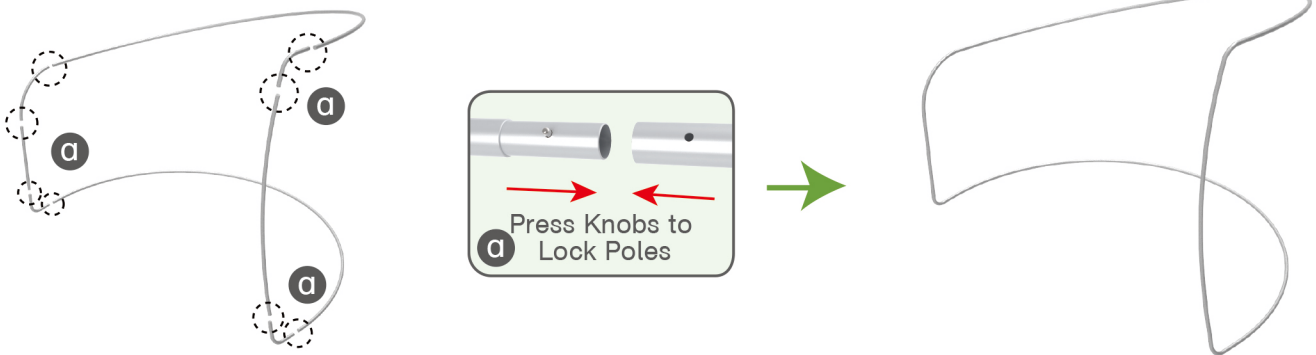

STEP 03

Connect support poles onto frame.

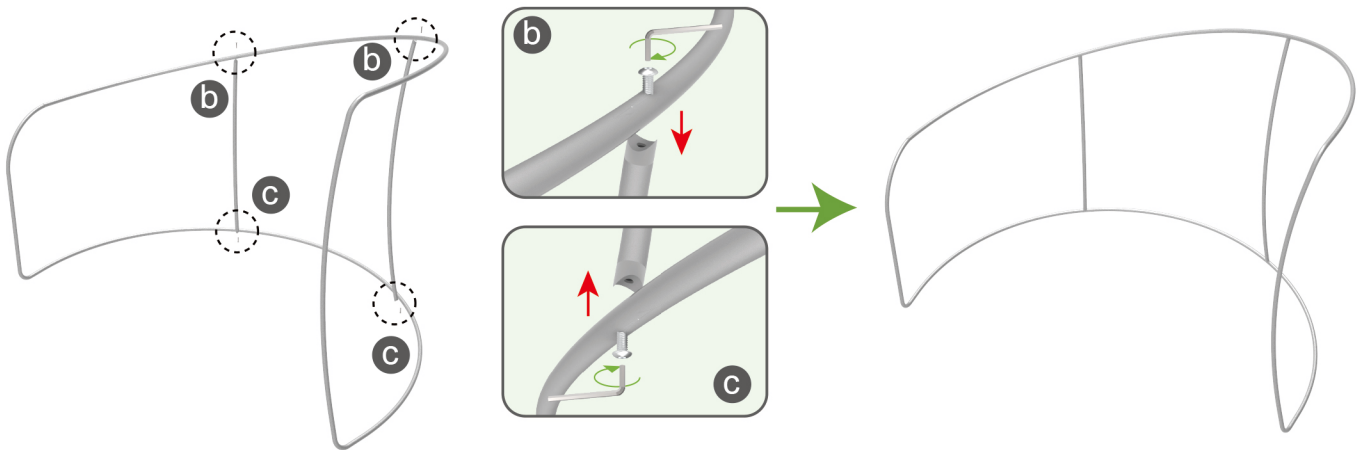

STEP 04

Wrap enclosure frame with fabric banner & zip up at top.

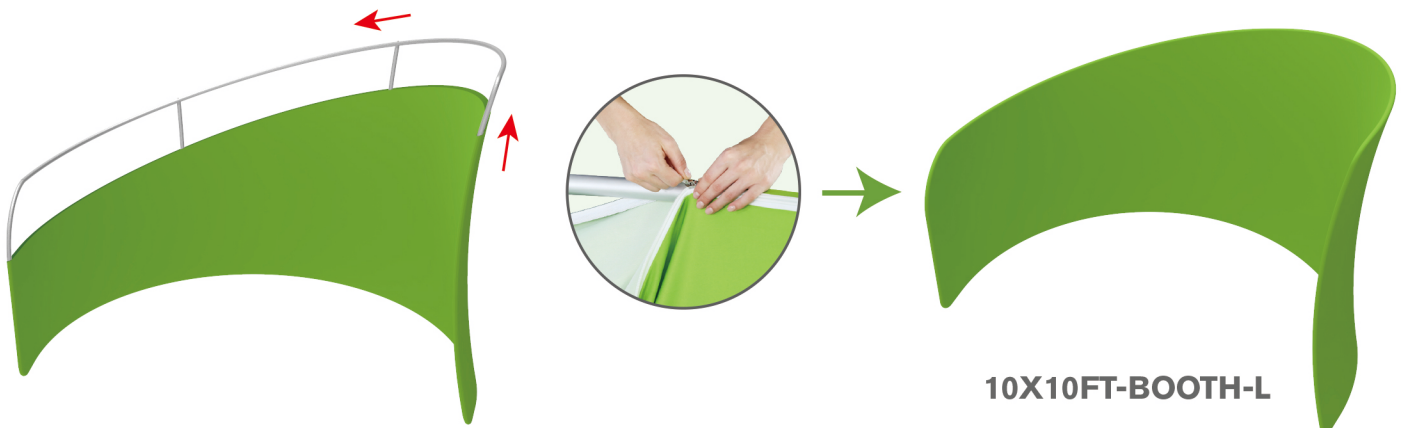

STEPS

(1) Durable Plastic Hard Case, Aluminum Support Poles



(2) Printed Graphic Fabric Banner



STEP 01

Put hard case's top into fabric banner.

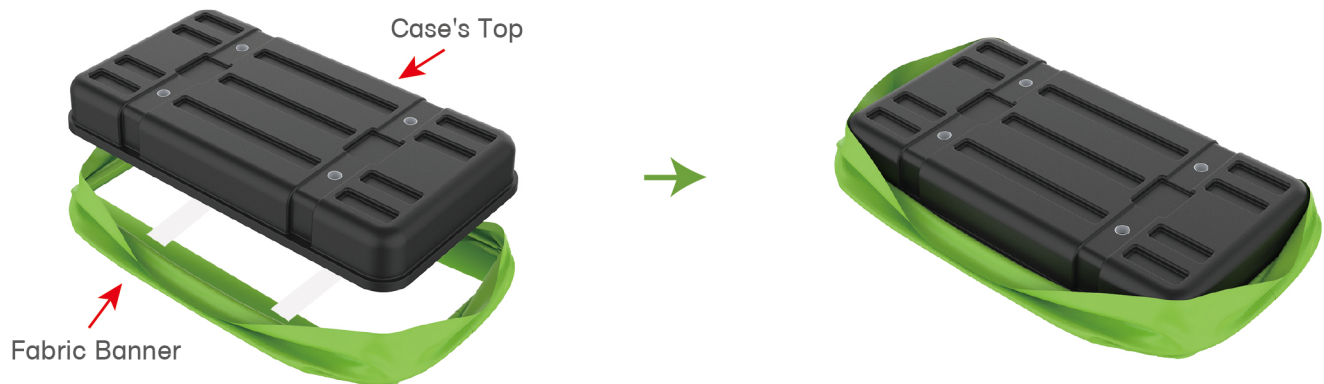

STEP 02

Insert support poles into hard case's top & bottom.

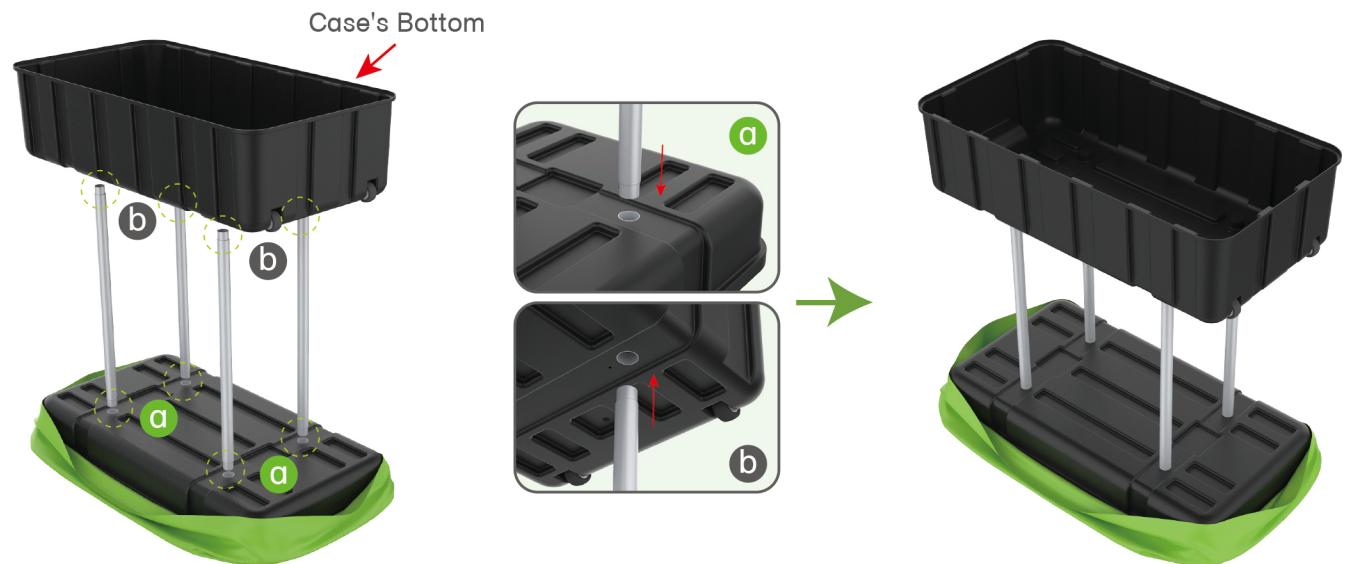

STEPS

STEP 04

Wrap fabric banner from bottom to top & twist it to be smooth, lay hard case's intermediate panel on podium's top.

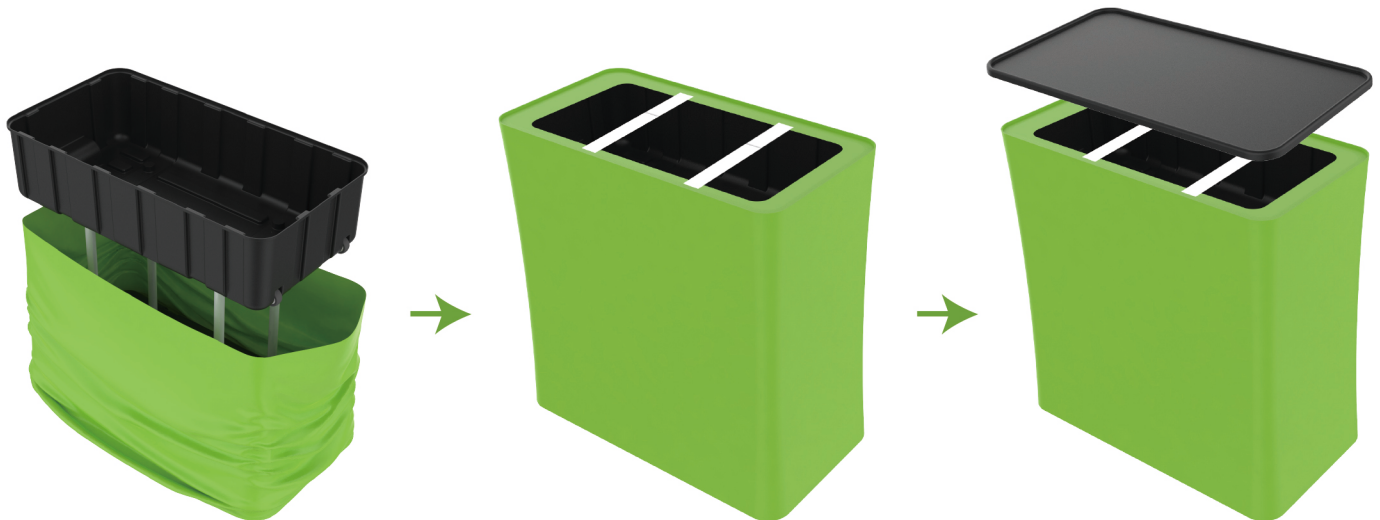

STEPS

(1) Hardware



(2) Countertop Panel

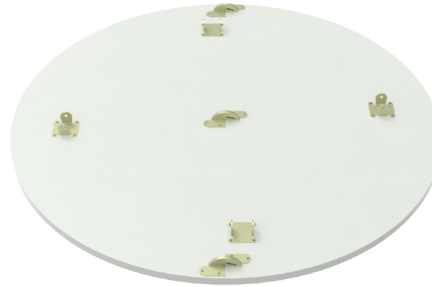

(3) Fixing Accessory



(4) Printed Graphic Fabric Banner



STEP 01

Connect to make long poles according to labelings.

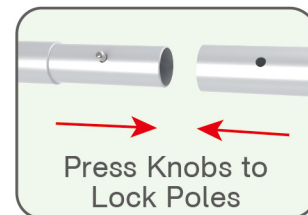

STEP 02

Insert poles into fixing accessory until you hear a 'Ding' sound to make poles' knobs clip into it & its concave parts pop out.



STEPS

STEP 03 Press poles' knobs to clip into countertop's slot.

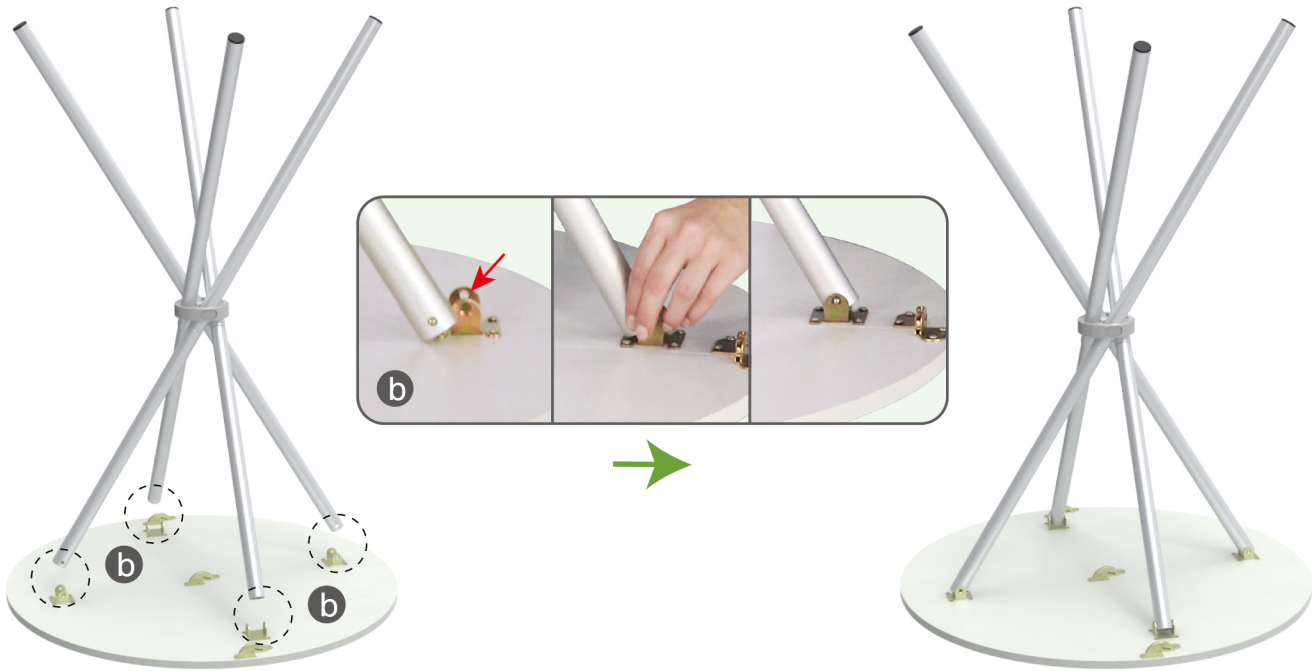

STEP 04

Wrap fabric banner from top to bottom, put poles into pockets & zip up.

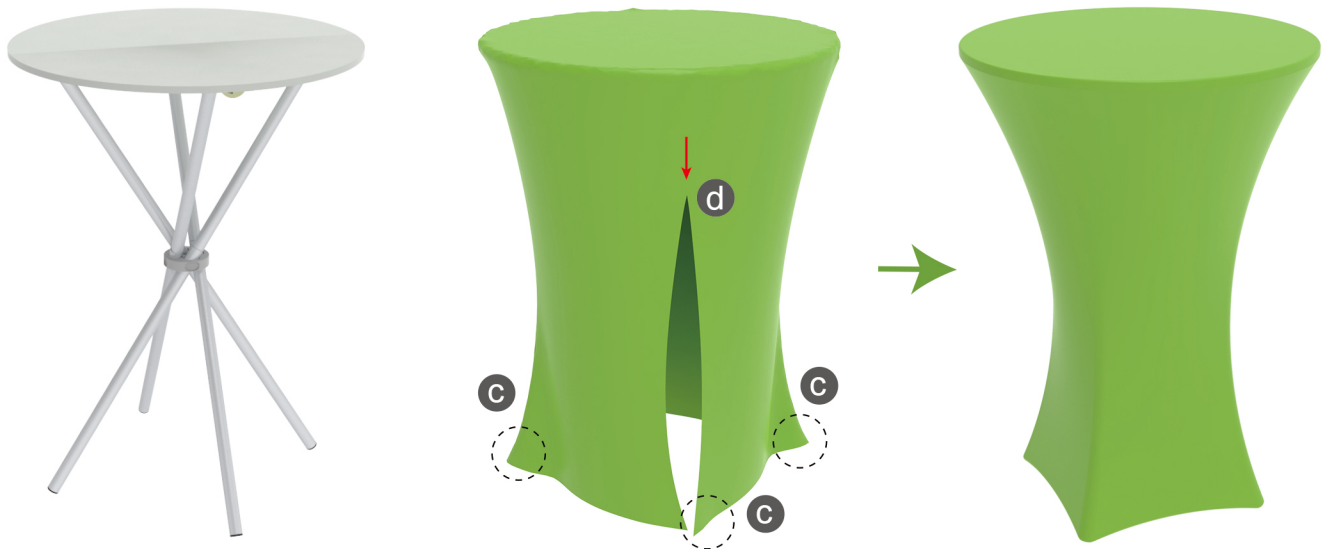
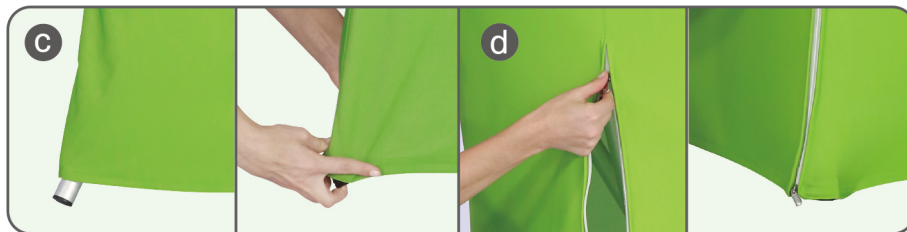

★ One Tool (Hex Wrench) 

STEPS

(1) Snap Tubes

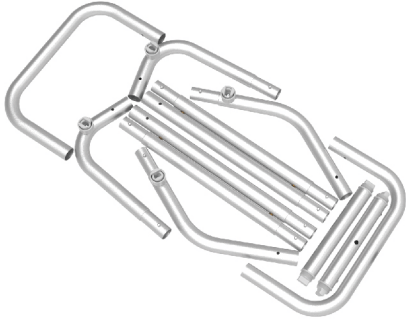

(2) Printed fabric banner



(3) Brochure rack x 2 / Screws x 4
Tablet PC holder x1

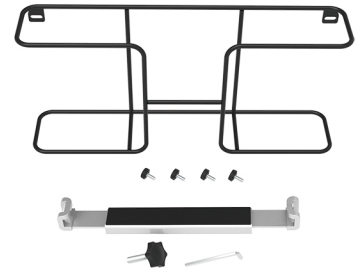

STEP 01

To Connect the tubes according to the labellings

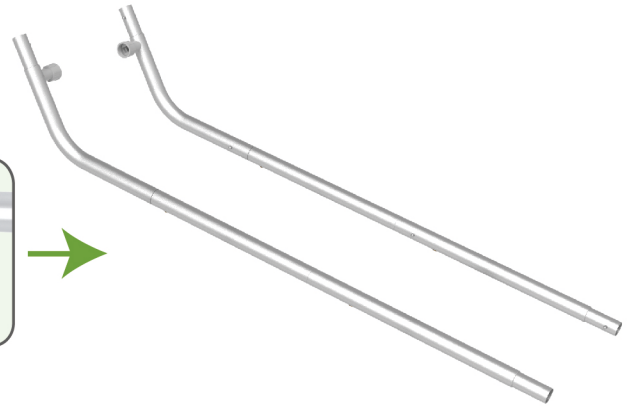
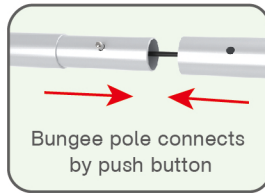

STEP 02

To connect 2 long side tubes by the corner pieces

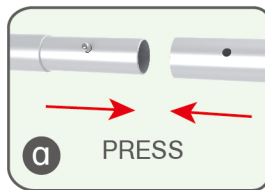

STEPS

STEP 03

To install the cross bar according to labellings

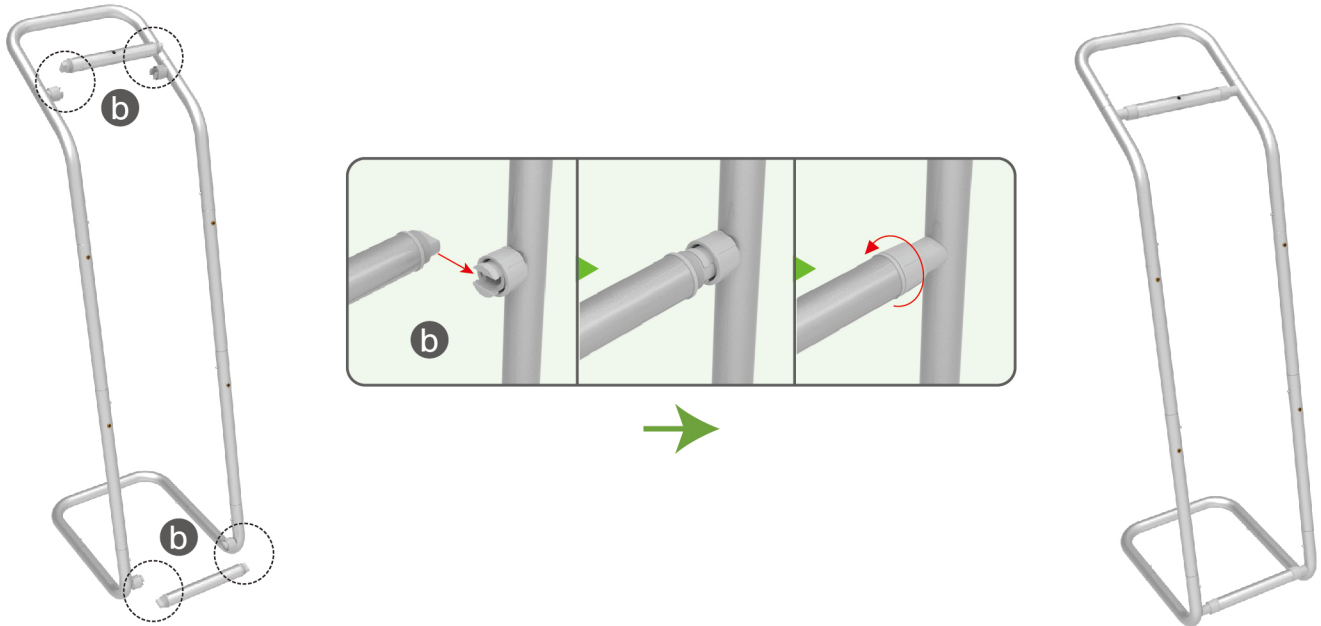

STEP 04

To wrap the fabric from top to the middle of frame, then put the iPad in the holder and adjust the holder to right size and lock it by Allen Key Afterwards, install the set to the display stand.

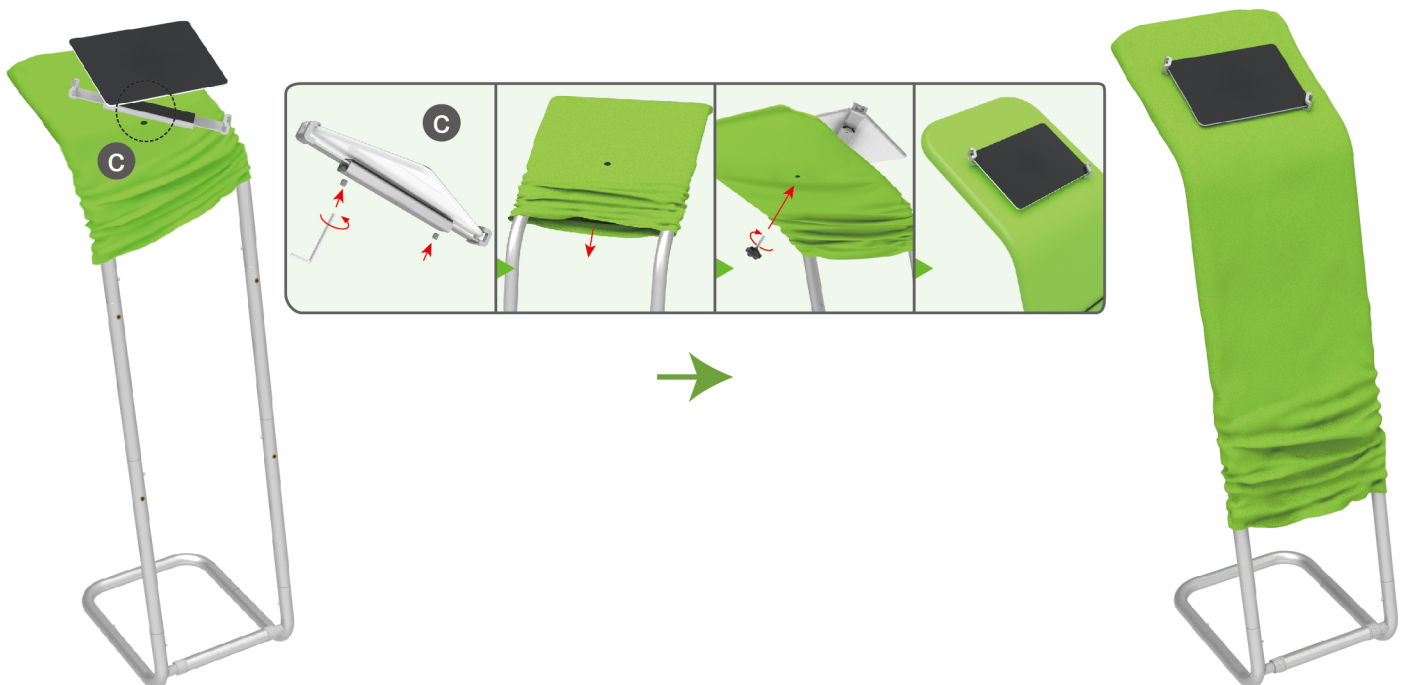

STEPS

STEP 05

To pull the fabric banner to bottom and zip up.



STEP 06

To Install 2 racks by screws in position

